

Pressure gauges with Bourdon tube without / with glycerine filling

Nominal size NG 63
Accuracy class 1,6

According to DIN EN 837-1



Features

High dynamic loads
Rugged construction

Applications

Food industrie,
Plant construction ,Chemical industry, Mining,
General Machine construction,
with glycerine filling : Compressors,
Pumps, Hydraulics

	with glycerine filling			
Model and ND	MR-20 63	MR-25 63	MR-20 63 F	MR-24 63 F
Connection	bottom	back,excentric	bottom	back,centric
Ranges in bar	0...1, 1,6, 2,5, 4, 6, 10, 16, 25, 40, 60, 100, 160, 250, 400, 600, 1.000 -1 / 0, -1 / +0,6, -1 / +1,5, -1 / +3, -1 / +5, -1 / +9, -1 / +15			
Application	permanent loading : to 3/4 max.rating dynamic loading : to 2/3 max. rating Overload protection : max. rating			
Case	CrNi steel			
Bezel	CrNi steel		CrNi steel	
Window	plexiglass			
Dial	Aluminium white , scale and imprint black			
Pointer	Aluminium , black			
Movement	CUZn -alloy,			
Measuring element	Copper alloy, up to 40 bar bourdon tube, from 60 bar helical tube stainless steel > 400 bar helical tube			
Connection	G 1/4 B			
Protection	IP 65 nach EN 60529 / IEC 529			
Temperatures	Medium: -20°C bis 80°C, ambient : -25°C bis 60°C			
Weight	0,2 kg		0,25 kg	

Dimensions

Connection bottom

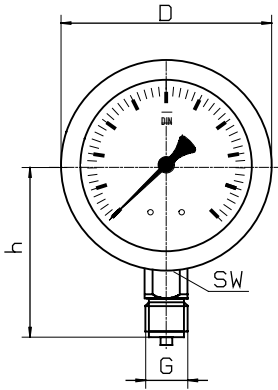

Front flange

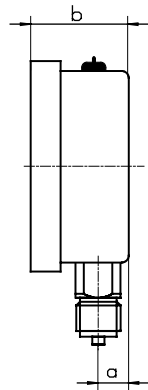
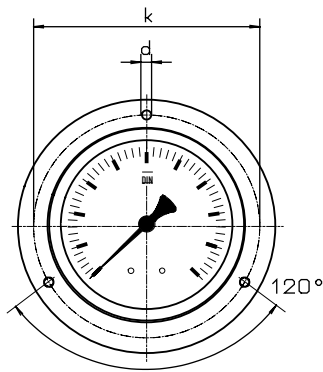

Rear flange

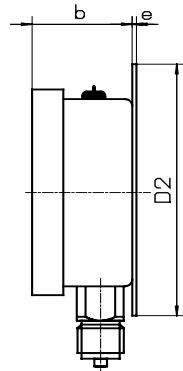

Connention back

Centric

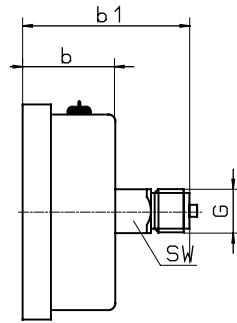

Front flange

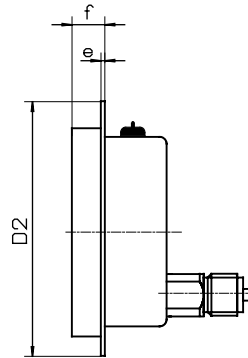

excentric

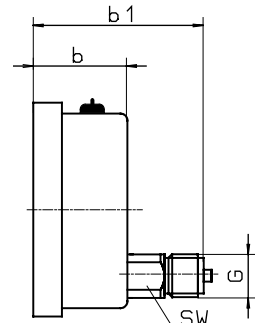

with triangle bezel and U-clamp,

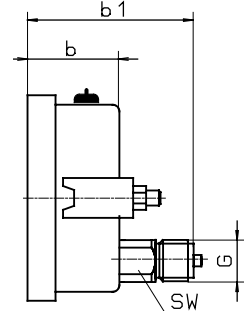

Dimensions in mm

Model	NG	D	a	b	b1	h		D2	e	f	k	d	sw	G
MR-20	63	68,5	9,5	31	-	53		85	3	16	75	3,7	14	G 1/4 B
MR-25	63	68,5	-	31	60	-		85	3	16	75	3,7	14	G 1/4 B
MR-20 F	63	68,5	9,5	31	-	53		85	3	16	75	3,7	14	G 1/4 B
MR-24 F	63	68,5	-	31	60	-		85	3	16	75	3,7	14	G 1/4 B

Modelspecification

Model
MR-3

Connection
0 or 5 (4)

Bottom = 0
Back centric = 4
Back excentric = 5

Filling

F or -

with filling = F

Nominal size

63

Range

f.e. 10 bar

after rangespecification
for 10 bar = 010

for example : front mounting flange

Options

