

**Standard series** Ø max 1/2" - up to 20 m length

Ø max 3/8" - up to 25 m length

Art. no. **9016-9021-9022**

Automatic rewind, spring-driven hose reel, standard series, in painted steel, suitable for hoses of max 20 m length (Ø hose 1/2") or max 25 m length (Ø hose 3/8"). The hose reel is supplied without hoses and can be used with hoses for the supply of oils, antifreeze, grease, compressed air and water.

Please see catalogue pages 242 and 243 for the selection of the required hoses.

On demand the hose reels can also be supplied with a **spring brake kit** (see information at the end of this page!); please add suffix **"/HB"** to the article number (f. ex. 9016/HB)!



Art. no. **9016-9021-9022**



Art. no. **9767**  
Art. no. **9768**

Pivoting wall mounting bracket

Art. no. **9517-9521-9522**

Automatic rewind, spring-driven hose reel, standard series, in stainless steel AISI 304, suitable for hoses of max 20 m length (Ø hose 1/2") or max 25 m length (Ø hose 3/8").

The hose reel is supplied without hoses and can be used with hoses for the supply of oils, antifreeze, grease, compressed air and water at low and high pressure.

Please see catalogue pages 242 and 243 for the selection of the required hoses.

On demand the hose reels can also be supplied with a **spring brake kit** (see information at the end of this page!); please add suffix **"/HB"** to the article number (f. ex. 9517/HB)!

(EX:) On demand these stainless steel hose reels can be supplied in accordance with directive ATEX 94/9/EC – group II – category 2.



Art. no. **9517-9521-9522**



Art. no. **9760**  
Art. no. **9765**

Pivoting wall mounting bracket



Art. no.	Max working pressure	Connection threads IN - OUT	Internal Ø swivel joint	Max Ø hose	Max length hose	Weight	Spool width	Suitable pivoting wall bracket	Included swivel joint	Dimensions (LxWxH) (mm)
<b>9016</b>	600 bar	1/2" (M) – 1/2" (F)	10 mm	1/2"	15 m	13 Kg	120 mm	9767	9951	250x570x450
<b>9021</b>	600 bar	1/2" (M) – 1/2" (F)	10 mm	1/2"	20 m	18 Kg	150 mm	9768	9951	260x570x450
<b>9022</b>	600 bar	1/2" (M) – 1/2" (F)	10 mm	3/8"	25 m	19 Kg	150 mm	9768	9951	260x570x450
<b>9517</b>	200 bar	1/2" (M) – 1/2" (F)	10 mm	1/2"	15 m	13 Kg	120 mm	9760	9963	250x570x450
<b>9521</b>	200 bar	1/2" (M) – 1/2" (F)	10 mm	3/8"	25 m	19 Kg	150 mm	9765	9963	260x570x450
<b>9522</b>	200 bar	1/2" (M) – 1/2" (F)	10 mm	1/2"	20 m	18 Kg	150 mm	9765	9963	260x570x450



**/HB Hydraulic spring brake kit**

Safety device for the controlled rewind of hoses, installable on all spring-driven hose reel models, eliminating the dangers caused by an uncontrolled rewind or a sudden release of the hose when unwinded during its use.

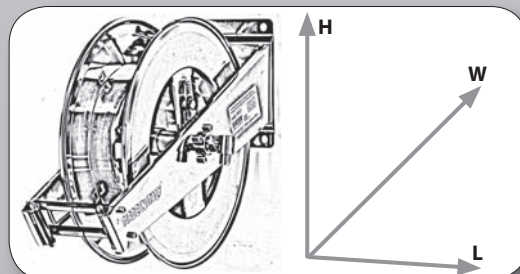

**Enclosed series    Ø max 1/2" - up to 20 m length**

**Ø max 3/8" - up to 25 m length**

Art. no. **9013 - 9023 - 9024 - 9025**



Art. no. **9013-9023-9024-9025**

Automatic rewind, spring-driven hose reel, **enclosed series**, in painted steel, suitable for hoses of max 20 m length (Ø hose 1/2") or max 25 m length (Ø hose 3/8"). The hose reel is supplied without hoses and can be used with hoses for the supply of oils, antifreeze, grease, compressed air, water and diesel.

Please see catalogue pages 242 and 243 for the selection of the required hoses.

On demand the hose reels can also be supplied with a **spring brake kit** (see information at the end of this page!); please add suffix **"/HB"** to the article number (f. ex. 9013/HB)!

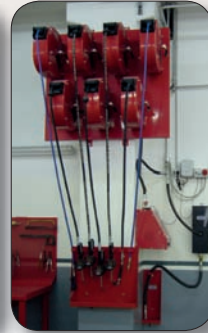

Art. no. **9778**

Pivoting wall mounting bracket

Art. no. **9546-9547-9548-9549**



Art. no. **9546-9547-9548-9549**

Automatic rewind, spring-driven hose reel, **enclosed series**, in stainless steel AISI 304, suitable for hoses of max 20 m length (Ø hose 1/2") or max 25 m length (Ø hose 3/8"). The hose reel is supplied without hoses and can be used with hoses for the supply of oils, antifreeze, grease, compressed air and water at low and high pressure.

Please see catalogue pages 242 and 243 for the selection of the required hoses.

On demand the hose reels can also be supplied with a **spring brake kit** (see information at the end of this page!); please add suffix **"/HB"** to the article number (f. ex. 9546/HB)!



Art. no. **9754**

Pivoting wall mounting bracket

Art. no.	Max working pressure	Connection threads IN - OUT	Internal Ø swivel joint	Max Ø hose	Max length hose	Weight	Spool width	Suitable pivoting wall bracket	Included swivel joint	Dimensions (LxWxH) (mm)
<b>9013</b>	600 bar	1/2" (M) - 1/2" (F)	10 mm	1/2"	15 m	26 Kg	120 mm	9778	9951	130x550x450
<b>9023</b>	600 bar	1/2" (M) - 1/2" (F)	10 mm	1/2"	20 m	27 Kg	150 mm	9778	9951	160x550x450
<b>9024</b>	20 bar	1/2" (M) - 1/2" (F)	20 mm	3/4"	8 m	26 Kg	150 mm	9778	9969	160x550x450
<b>9025</b>	600 bar	1" (M) - 3/4" (F)	10 mm	3/8"	25 m	29 Kg	150 mm	9778	9951	160x550x450
<b>9546</b>	20 bar	1/2" (M) - 1/2" (F)	20 mm	3/4"	8 m	26 Kg	150 mm	9754	9986	160x550x450
<b>9547</b>	200 bar	1" (M) - 3/4" (F)	10 mm	1/2"	15 m	26 Kg	120 mm	9754	9963	130x550x450
<b>9548</b>	200 bar	1/2" (M) - 1/2" (F)	10 mm	1/2"	20 m	27 Kg	150 mm	9754	9963	160x550x450
<b>9549</b>	200 bar	1/2" (M) - 1/2" (F)	10 mm	3/8"	25 m	29 Kg	150 mm	9754	9963	160x550x450



**/HB Hydraulic spring brake kit**

Safety device for the controlled rewind of hoses, installable on all spring-driven hose reel models, eliminating the dangers caused by an uncontrolled rewind or a sudden release of the hose when unwinded during its use.

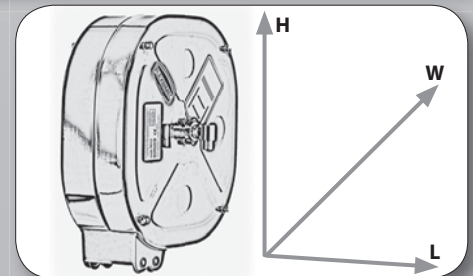



## Adjustable arms series EVO Ø max 1/2" – up to 25 m length



Art. no. 9090-9091-9092-9093

### Art. no. 9090 – 9091 – 9092 – 9093

Automatic rewind, spring-driven hose reel, **adjustable arms series EVO**, in painted steel, suitable for hoses of max 25 m length and max diameter of 1/2". The hose reel is supplied without hoses and can be used with hoses for the supply of oils, antifreeze, grease, compressed air and water. From the inlet swivel joint the fluid flows through an interchangeable hose connection adapter assembly on which the hose is mounted (standard version galvanized steel, available on demand also in stainless steel AISI 304 or AISI 316). Please see catalogue pages 242 and 243 for the selection of the required hoses. On demand the hose reels can also be supplied with a **spring brake kit** (see information at the end of this page!); please add suffix **"/HB"** to the article number (f. ex. 9090/HB)!



Art. no. 9767  
Art. no. 9768  
Art. no. 9758



Art. no. 9590-9591-9592-9593

### Art. no. 9590 – 9591 – 9592 – 9593

Automatic rewind, spring-driven hose reel, **adjustable arms series EVO**, in stainless steel AISI 304, suitable for hoses of max 25 m length and max diameter of 1/2". The hose reel is supplied without hoses and can be used with hoses for the supply of oils, antifreeze, grease, compressed air and water. From the inlet swivel joint the fluid flows through an interchangeable hose connection adapter assembly on which the hose is mounted (standard version stainless steel AISI 304, available on demand also in stainless steel AISI 316). Please see catalogue pages 242 and 243 for the selection of the required hoses. On demand the hose reels can also be supplied with a **spring brake kit** (see information at the end of this page!); please add suffix **"/HB"** to the article number (f. ex. 9590/HB)!



Art. no. 9760  
Art. no. 9765  
Art. no. 9775



On demand these stainless steel hose reels can be supplied in accordance with directive ATEX 94/9/EC – group II – category 2.

Art. no.	Max working pressure	Connection threads IN - OUT	Internal ø swivel joint	Max ø hose	Max length hose 3/8" – 1/2"	Weight	Spool width	Suitable pivoting wall bracket	Included swivel joint	Dimensions (LxWxH) (mm)
9090	600 bar	1/2" (M) – 1/2" (F)	10 mm	1/2"	15 m	12 kg	120 mm	9767	9951	240x550x450
9091	600 bar	1/2" (M) – 1/2" (F)	10 mm	1/2"	20 m -15 m	13 kg	120 mm	9767	9951	240x550x450
9092	600 bar	1/2" (M) – 1/2" (F)	10 mm	1/2"	25 m –20 m	16 kg	150 mm	9768	9951	270x550x450
9093	600 bar	1/2" (M) – 1/2" (F)	10 mm	1/2"	25 m	19 kg	200 mm	9758	9951	310x550x450
9590	200 bar	1/2" (M) – 1/2" (F)	10 mm	1/2"	15 m	12 kg	120 mm	9760	9963	240x550x450
9591	200 bar	1/2" (M) – 1/2" (F)	10 mm	1/2"	20 m -15 m	13 kg	120 mm	9760	9963	240x550x450
9592	200 bar	1/2" (M) – 1/2" (F)	10 mm	1/2"	25 m –20 m	16 kg	150 mm	9765	9963	270x550x450
9593	200 bar	1/2" (M) – 1/2" (F)	10 mm	1/2"	25 m	19 kg	200 mm	9775	9963	310x550x450



### **/HB** Hydraulic spring brake kit

Safety device for the controlled rewind of hoses, installable on all spring-driven hose reel models, eliminating the dangers caused by an uncontrolled rewind or a sudden release of the hose when unwinded during its use.

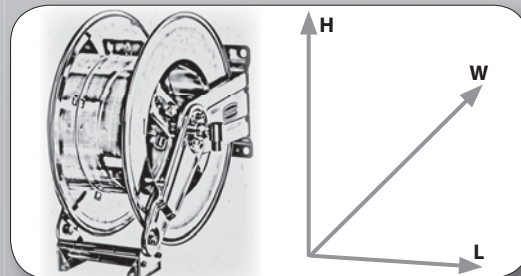

## Adjustable arms series $\varnothing$ max 1/2" - up to 35 m length



Art. no. 9074 - 9083

### Art. no. 9074 - 9083

Automatic rewind, spring-driven hose reel, **adjustable arms series**, in painted steel, suitable for hoses of max 35 m length and max diameter of 1/2".

The hose reel is supplied without hoses and can be used with hoses for the supply of oils, antifreeze, grease, compressed air and water. From the inlet swivel joint the fluid flows through an interchangeable hose connection adapter assembly on which the hose is mounted (standard version galvanized steel, available on demand also in stainless steel AISI 304 or AISI 316). Please see catalogue pages 242 and 243 for the selection of the required hoses. On demand the hose reels can also be supplied with a **spring brake kit** (see information at the end of this page!); please add suffix **"/HB"** to the article number (f. ex. 9074/HB)!

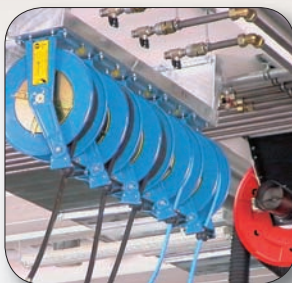

### Art. no. 9777

Pivoting wall mounting bracket for art. no. 9074 and art. no. 9083.



Art. no. 9777



Art. no. 9574 - 9530

### Art. no. 9574 - 9530

Automatic rewind, spring-driven hose reel, **adjustable arms series**, in stainless steel AISI 304, suitable for hoses of max 35 m length and max diameter of 1/2".

The hose reel is supplied without hoses and can be used with hoses for the supply of oils, antifreeze, grease, compressed air and water. From the inlet swivel joint the fluid flows through an interchangeable hose connection adapter assembly on which the hose is mounted (standard version stainless steel AISI 304, available on demand also in stainless steel AISI 316).

Please see catalogue pages 242 and 243 for the selection of the required hoses.

On demand the hose reels can also be supplied with a **spring brake kit** (see information at the end of this page!); please add suffix **"/HB"** to the article number (f. ex. 9574/HB)!



### Art. no. 9770

Pivoting wall mounting bracket for art. no. 9574 and art. no. 9530.



Art. no. 9770



On demand these stainless steel hose reels can be supplied in accordance with directive ATEX 94/9/EC – group II – category 2.

Art. no.	Max working pressure	Connection threads IN - OUT	Internal $\varnothing$ swivel joint	Max $\varnothing$ hose	Max length hose	Weight	Spool width	Suitable pivoting wall bracket	Included swivel joint	Dimensions (LxWxH) (mm)
<b>9074</b>	600 bar	1/2" (M) – 1/2" (F)	10 mm	1/2"	30 m	25 kg	150 mm	9777	9951	260x590x600
<b>9083</b>	600 bar	1/2" (M) – 1/2" (F)	10 mm	1/2"	35 m	26 kg	150 mm	9777	9951	260x590x600
<b>9574</b>	200 bar	1/2" (M) – 1/2" (F)	10 mm	1/2"	30 m	25 kg	150 mm	9770	9963	260x590x600
<b>9530</b>	200 bar	1/2" (M) – 1/2" (F)	10 mm	1/2"	35 m	26 kg	150 mm	9770	9963	260x590x600



### **/HB** Hydraulic spring brake kit

Safety device for the controlled rewind of hoses, installable on all spring-driven hose reel models, eliminating the dangers caused by an uncontrolled rewind or a sudden release of the hose when unwinded during its use.

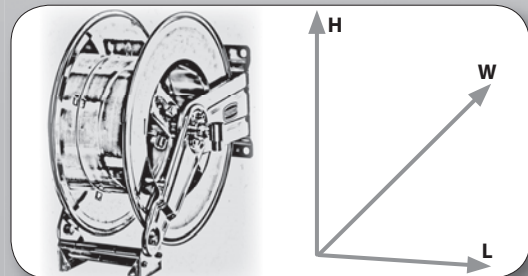



## Adjustable arms series Ø max 1/2" – up to 60 m length

Art. no. **9086**

Automatic rewind, spring-driven hose reel, **adjustable arms series** with twin spring, in painted steel, suitable for hoses of max 60 m length and max diameter of 1/2".

The hose reel is supplied without hoses and can be used with hoses for the supply of oils, antifreeze, grease, compressed air and water at low and high pressure.

Please see catalogue pages 242 and 243 for the selection of the required hoses.

On demand the hose reels can also be supplied with a **spring brake kit** (see information at the end of this page!); please add suffix **"/HB"** to the article number (f. ex. 9086/HB)!



Art. no. **9086**



Art. no. **9586**

Automatic rewind, spring-driven hose reel, **adjustable arms series** with twin spring, in stainless steel AISI 304, suitable for hoses of max 60 m length and max diameter of 1/2".

The hose reel is supplied without hoses and can be used with hoses for the supply of oils, antifreeze, grease, compressed air and water at low and high pressure.

Please see catalogue pages 242 and 243 for the selection of the required hoses.

On demand the hose reels can also be supplied with a **spring brake kit** (see information at the end of this page!); please add suffix **"/HB"** to the article number (f. ex. 9586/HB)!



Art. no. **9586**



On demand these stainless steel hose reels can be supplied in accordance with directive ATEX 94/9/EC – group II – category 2.

Art. no.	Max working pressure	Connection threads IN - OUT	Internal Ø swivel joint	Max Ø hose	Max length hose	Weight	Spool width	Included swivel joint	Dimensions (LxWxH) (mm)
<b>9086</b>	600 bar	1/2" (M) – 1/2" (F)	10 mm	1/2"	60 m	50 Kg	400 mm	9951	590x590x590
<b>9586</b>	200 bar	1/2" (M) – 1/2" (F)	10 mm	1/2"	60 m	50 Kg	400 mm	9963	590x590x590



### **/HB** Hydraulic spring brake kit

Safety device for the controlled rewind of hoses, installable on all spring-driven hose reel models, eliminating the dangers caused by an uncontrolled rewind or a sudden release of the hose when unwinded during its use.

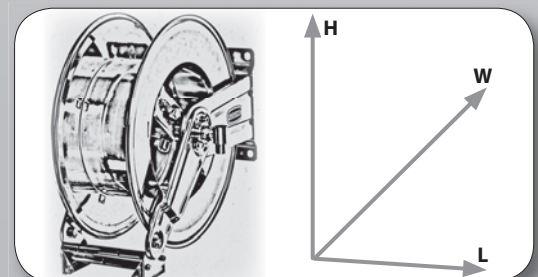

## Adjustable arms series Ø max 1/2" – up to 100 m length

Art. no. **9088**

Automatic rewind, spring-driven hose reel, **adjustable arms series** with triple spring, in painted steel, suitable for hoses of max 100 m length and max diameter of 1/2".

The hose reel is supplied without hoses and can be used with hoses for the supply of oils, antifreeze, grease, compressed air and water at low and high pressure. Please see catalogue pages 242 and 243 for the selection of the required hoses.

On demand the hose reels can also be supplied with a **spring brake kit** (see information at the end of this page!); please add suffix **"/HB"** to the article number (f. ex. 9088/HB)!

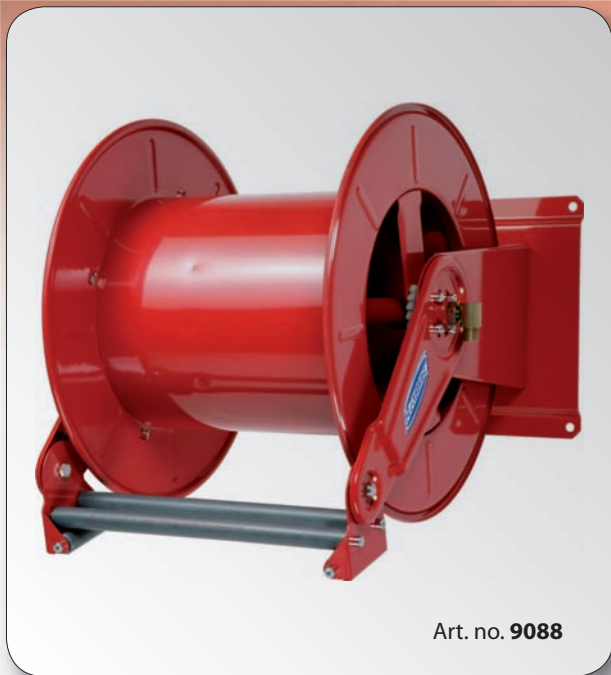

Art. no. **9088**



Art. no. **9589**

Automatic rewind, spring-driven hose reel, **adjustable arms series** with triple spring, in stainless steel AISI 304, suitable for hoses of max 100 m length and max diameter of 1/2".

The hose reel is supplied without hoses and can be used with hoses for the supply of oils, antifreeze, grease, compressed air and water at low and high pressure. Please see catalogue pages 242 and 243 for the selection of the required hoses.

On demand the hose reels can also be supplied with a **spring brake kit** (see information at the end of this page!); please add suffix **"/HB"** to the article number (f. ex. 9589/HB)!



Art. no. **9589**

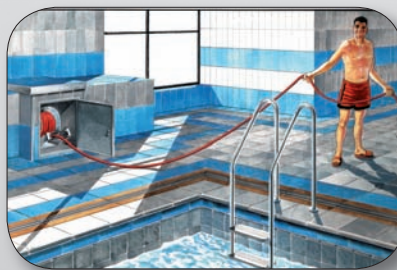

On demand these stainless steel hose reels can be supplied in accordance with directive ATEX 94/9/EC – group II – category 2.

Art. no.	Max working pressure	Connection threads IN - OUT	Internal Ø swivel joint	Max Ø hose	Max length hose	Weight	Spool width	Included swivel joint	Dimensions (LxWxH) (mm)
<b>9088</b>	600 bar	1/2" (M) – 1/2" (F)	10 mm	1/2"	100 m	70 Kg	400 mm	9951	590x590x590
<b>9589</b>	200 bar	1/2" (M) – 1/2" (F)	10 mm	1/2"	100 m	70 Kg	400 mm	9963	590x590x590



### **/HB Hydraulic spring brake kit**

Safety device for the controlled rewind of hoses, installable on all spring-driven hose reel models, eliminating the dangers caused by an uncontrolled rewind or a sudden release of the hose when unwinded during its use.

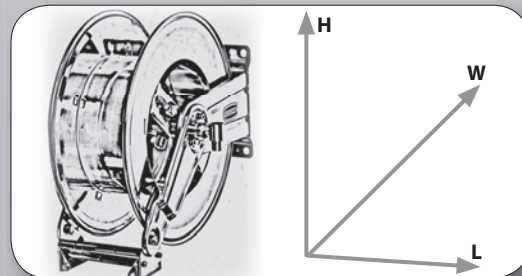



## Adjustable arms series EVO Ø max 1" – up to 15 m length

Art. no. **9095 - 9096 - 9097**

Automatic rewind, spring-driven hose reel, **adjustable arms series EVO**, in painted steel, suitable for hoses of max 18 m length in 3/4" and max 15 m length in 1".

This series is an upgraded version of the previous adjustable arms series. The wall bracket and the side frame are made in one single piece to increase the stability. A new type of spring is installed for the hose rewind. From the inlet swivel joint the fluid flows through an interchangeable hose connection adapter assembly on which the hose is mounted (standard version galvanized steel, available on demand also in stainless steel AISI 316). The hose reel is supplied without hoses and can be used with hoses for the supply of oils, diesel, compressed air and water. Please see catalogue pages 242 and 243 for the selection of the required hoses. On demand the hose reels can also be supplied with a **spring brake kit** (see information at the end of this page!); please add suffix **"/HB"** to the article number (f. ex. 9095/HB)!



Pivoting wall mounting bracket



Art. no. **9584 - 9595 - 9596**

Automatic rewind, spring-driven hose reel, **adjustable arms series EVO**, in stainless steel AISI 304, suitable for hoses of max 18 m length in 3/4" and max 15 m length in 1". This series is an upgraded version of the previous adjustable arms series. The wall bracket and the side frame are made in one single piece to increase the stability. A new type of spring is installed for the hose rewind. From the inlet swivel joint the fluid flows through an interchangeable hose connection adapter assembly on which the hose is mounted (standard version stainless steel AISI 304, available on demand also in stainless steel AISI 316). The hose reel is supplied without hoses and can be used with hoses for the supply of oils, diesel, compressed air and water. Please see catalogue pages 242 and 243 for the selection of the required hoses. On demand the hose reels can also be supplied with a **spring brake kit** (see information at the end of this page!); please add suffix **"/HB"** to the article number (f. ex. 9584/HB)!



Pivoting wall mounting bracket



On demand these stainless steel hose reels can be supplied in accordance with directive ATEX 94/9/EC – group II – category 2.

Art. no.	Max working pressure	Connection threads IN - OUT	Internal Ø swivel joint	Max Ø hose	Max length hose 3/4" - 1"	Weight	Spool width	Suitable pivoting wall bracket	Included swivel joint	Dimensions (LxWxH) (mm)
<b>9095</b>	100 bar	1" (M) - 1" (F)	20 mm	1"	10 m - 8 m	18 kg	150 mm	9768	9969	270x530x490
<b>9096</b>	100 bar	1" (M) - 1" (F)	20 mm	1"	15 m - 12 m	22 kg	200 mm	9773	9969	310x530x490
<b>9097</b>	100 bar	1" (M) - 1" (F)	20 mm	1"	18 m - 15 m	24 kg	300 mm	9769	9969	410x530x490
<b>9595</b>	100 bar	1" (M) - 1" (F)	20 mm	1"	10 m - 8 m	18 kg	150 mm	9765	9986	270x530x490
<b>9596</b>	100 bar	1" (M) - 1" (F)	20 mm	1"	15 m - 12 m	22 kg	200 mm	9776	9986	310x530x490
<b>9584</b>	100 bar	1" (M) - 1" (F)	20 mm	1"	18 m - 15 m	24 kg	300 mm	9764	9986	410x530x490



### **/HB** Hydraulic spring brake kit

Safety device for the controlled rewind of hoses, installable on all spring-driven hose reel models, eliminating the dangers caused by an uncontrolled rewind or a sudden release of the hose when unwinded during its use.

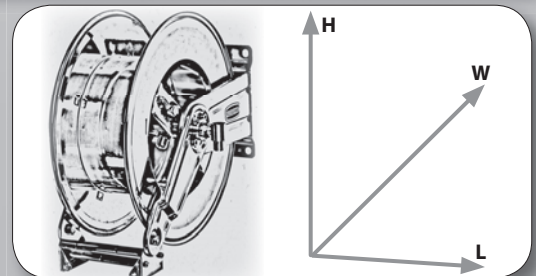

## Adjustable arms series EVO Ø max 3/4" – up to 30 m length

### Ø max 1" – up to 20 m length



Art. no. 9070-9084-9098

Art. no. 9070 - 9084 - 9098

Automatic rewind, spring-driven hose reel, **adjustable arms series EVO** with twin spring, in painted steel, suitable for hoses of max 30 m length in 3/4" and max 20 m length in 1". The hose reel is supplied without hoses and can be used with hoses for the supply of oils, diesel, compressed air and water. From the inlet swivel joint the fluid flows through an interchangeable hose connection adapter assembly on which the hose is mounted (standard version galvanized steel, available on demand also in stainless steel AISI 304 or AISI 316). Please see catalogue pages 242 and 243 for the selection of the required hoses. On demand the hose reels can also be supplied with a **spring brake kit** (see information at the end of this page!); please add suffix "/HB" to the article number (f. ex. 9070/HB)!



Art. no. 9777  
Pivoting wall mounting bracket for art. no. 9098 - 9084.

Art. no. 9769  
Pivoting wall mounting bracket for art. no. 9070.



Art. no. 9777  
Art. no. 9769



Art. no. 9534-9570-9598

Art. no. 9534 - 9570 - 9598

Automatic rewind, spring-driven hose reel, **adjustable arms series EVO** with twin spring, in stainless steel AISI 304, suitable for hoses of max 30 m length in 3/4" and max 20 m length in 1".

The hose reel is supplied without hoses and can be used with hoses for the supply of oils, diesel, compressed air and water. From the inlet swivel joint the fluid flows through an interchangeable hose connection adapter assembly on which the hose is mounted (standard version stainless steel AISI 304, available on demand also in stainless steel AISI 316). Please see catalogue pages 242 and 243 for the selection of the required hoses.

On demand the hose reels can also be supplied with a **spring brake kit** (see information at the end of this page!); please add suffix "/HB" to the article number (f. ex. 9534/HB)!



Art. no. 9770  
Pivoting wall mounting bracket for art. no. 9598 - 9534.

Art. no. 9764  
Pivoting wall mounting bracket for art. no. 9570.



Art. no. 9770  
Art. no. 9764



On demand these stainless steel hose reels can be supplied in accordance with directive ATEX 94/9/EC – group II – category 2.

Art. no.	Max working pressure	Connection threads IN - OUT	Internal ø swivel joint	Max ø hose	Max length hose 3/4" - 1"	Weight	Spool width	Suitable pivoting wall bracket	Included swivel joint	Dimensions (LxWxH) (mm)
9084	100 bar	1" (M) - 1" (F)	20 mm	1"	20 m - 15 m	27 kg	150 mm	9777	9969	270x590x600
9098	100 bar	1" (M) - 1" (F)	20 mm	1"	25 m - 18 m	30 kg	200 mm	9777	9969	320x590x700
9070	100 bar	1" (M) - 1" (F)	20 mm	1"	30 m - 20 m	32 kg	300 mm	9769	9969	460x590x700
9534	100 bar	1" (M) - 1" (F)	20 mm	1"	20 m - 15 m	27 kg	150 mm	9770	9986	270x590x600
9598	100 bar	1" (M) - 1" (F)	20 mm	1"	25 m - 18 m	30 kg	200 mm	9770	9986	320x590x700
9570	100 bar	1" (M) - 1" (F)	20 mm	1"	30 m - 20 m	32 kg	300 mm	9764	9986	460x590x700



### /HB Hydraulic spring brake kit

Safety device for the controlled rewind of hoses, installable on all spring-driven hose reel models, eliminating the dangers caused by an uncontrolled rewind or a sudden release of the hose when unwinded during its use.

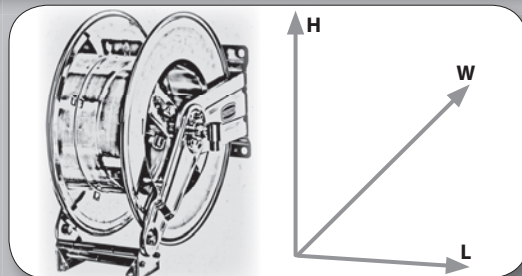



## Adjustable arms series Ø max 1" - up to 30 m length



Art. no. 9099

Art. no. 9099

Automatic rewind, spring-driven hose reel, **adjustable arms series** with twin spring, in painted steel, suitable for hoses of max 30 m length in 1". The hose reel is supplied without hoses and can be used with hoses for the supply of oils, antifreeze, diesel, compressed air and water at low pressure. Please see catalogue pages 242 and 243 for the selection of the required hoses.

On demand the hose reels can also be supplied with a **spring brake kit** (see information at the end of this page!); please add suffix **"/HB"** to the article number (f. ex. 9099/HB)!



Art. no. 9599

Art. no. 9599

Automatic rewind, spring-driven hose reel, **adjustable arms series** with twin spring, in stainless steel AISI 304, suitable for hoses of max 30 m length in 1". The hose reel is supplied without hoses and can be used with hoses for the supply of oils, antifreeze, diesel, compressed air and water at low pressure. Please see catalogue pages 242 and 243 for the selection of the required hoses.

On demand the hose reels can also be supplied with a **spring brake kit** (see information at the end of this page!); please add suffix **"/HB"** to the article number (f. ex. 9599/HB)!



On demand these stainless steel hose reels can be supplied in accordance with directive ATEX 94/9/EC – group II – category 2.

Art. no.	Max working pressure	Connection threads IN - OUT	Internal ø swivel joint	Max ø hose	Max length hose	Weight	Spool width	Included swivel joint	Dimensions (LxWxH) (mm)
9099	100 bar	1" (M) – 1" (F)	20 mm	1"	30 m	50 Kg	400 mm	9969	590x650x590
9599	100 bar	1" (M) – 1" (F)	20 mm	1"	30 m	50 Kg	400 mm	9986	590x650x590



### **/HB** Hydraulic spring brake kit

Safety device for the controlled rewind of hoses, installable on all spring-driven hose reel models, eliminating the dangers caused by an uncontrolled rewind or a sudden release of the hose when unwinded during its use.

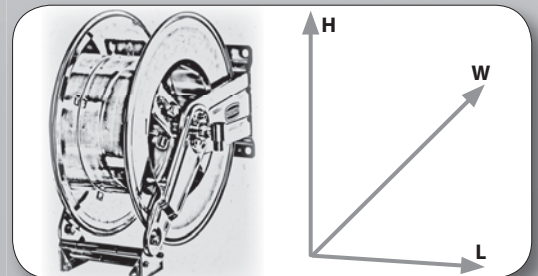

## Adjustable arms series Ø max 3/4" - up to 40 m length



Art. no. **9085**

Art. no. **9085**

Automatic rewind, spring-driven hose reel, **adjustable arms series** with twin spring, in painted steel, suitable for hoses of max 40 m length in 3/4".

The hose reel is supplied without hoses and can be used with hoses for the supply of oils, antifreeze, grease, compressed air and water.

Please see catalogue pages 242 and 243 for the selection of the required hoses.

On demand the hose reels can also be supplied with a **spring brake kit** (see information at the end of this page!); please add suffix **"/HB"** to the article number (f. ex. 9085/HB)!

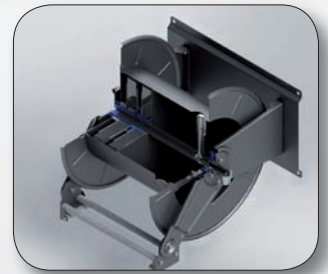

Art. no. **9585**

Art. no. **9585**

Automatic rewind, spring-driven hose reel, **adjustable arms series** with twin spring, in stainless steel AISI 304, suitable for hoses of max 40 m length in 3/4".

The hose reel is supplied without hoses and can be used with hoses for the supply of oils, antifreeze, grease, compressed air and water.

Please see catalogue pages 242 and 243 for the selection of the required hoses.

On demand the hose reels can also be supplied with a **spring brake kit** (see information at the end of this page!); please add suffix **"/HB"** to the article number (f. ex. 9585/HB)!



On demand these stainless steel hose reels can be supplied in accordance with directive ATEX 94/9/EC – group II – category 2.

Art. no.	Max working pressure	Connection threads IN - OUT	Internal ø swivel joint	Max ø hose	Max length hose	Weight	Spool width	Included swivel joint	Dimensions (LxWxH) (mm)
<b>9085</b>	100 bar	1" (M) – 1" (F)	20 mm	3/4"	40 m	50 Kg	400 mm	9969	590x650x590
<b>9585</b>	100 bar	1" (M) – 1" (F)	20 mm	3/4"	40 m	50 Kg	400 mm	9986	590x650x590



### **/HB Hydraulic spring brake kit**

Safety device for the controlled rewind of hoses, installable on all spring-driven hose reel models, eliminating the dangers caused by an uncontrolled rewind or a sudden release of the hose when unwinded during its use.

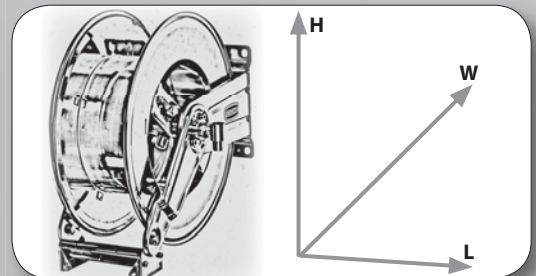



**Adjustable arms series EVO-MY10    Ø max 1'1/4" – up to 20 m length**

**Ø max 1'1/2" – up to 15 m length**



Art. no. 9031 - 9038 - 9039

Art. no. 9031 - 9038 - 9039

Automatic rewind, spring-driven hose reel, **adjustable arms series-EVO**, in painted steel, suitable for applications with high delivery rates and for hoses of max 20 m length in 1' 1/4" and max 15 m length in 1' 1/2".

The hose reel is supplied without hoses and can be used with hoses for the supply of oils, diesel, compressed air and water. From the inlet swivel joint the fluid flows through an interchangeable hose connection adapter assembly on which the hose is mounted (standard version galvanized steel, available on demand also in stainless steel AISI 304 or AISI 316).

Please see catalogue pages 242 and 243 for the selection of the required hoses.

On demand the hose reels can also be supplied with a **spring brake kit** (see information at the end of this page!); please add suffix **"/HB"** to the article number (f. ex. 9031/HB)!



Art. no. 9531 - 9538 - 9539

Art. no. 9531 - 9538 - 9539

Automatic rewind, spring-driven hose reel, **adjustable arms series EVO**, in stainless steel AISI 304, suitable for applications with high delivery rates and for hoses of max 20 m length in 1' 1/4" and max 15 m length in 1' 1/2".

The hose reel is supplied without hoses and can be used with hoses for the supply of oils, diesel, compressed air and water. From the inlet swivel joint the fluid flows through an interchangeable hose connection adapter assembly on which the hose is mounted (standard version stainless steel AISI 304, available on demand also in stainless steel AISI 316). Please see catalogue pages 242 and 243 for the selection of the required hoses.

On demand the hose reels can also be supplied with a **spring brake kit** (see information at the end of this page!); please add suffix **"/HB"** to the article number (f. ex. 9531/HB)!



On demand these stainless steel hose reels can be supplied in accordance with directive ATEX 94/9/EC – group II – category 2.

Art. no.	Max working pressure	Connection threads IN - OUT	Internal ø swivel joint	Max ø hose	Max length hose	Weight	Spool width	Included swivel joint	Dimensions (LxWxH) (mm)
9031	20 bar	1' 1/4" (M) – 1' 1/4" (F)	25 mm	1' 1/4"	8 m	18 kg	200 mm	9982	330x650x600
9038	20 bar	1' 1/4" (M) – 1' 1/4" (F)	25 mm	1' 1/4"	20 m	49 kg	400 mm	9982	590x650x600
9039	20 bar	1' 1/2" (M) – 1' 1/2" (F)	32 mm	1' 1/2"	15 m	50 kg	400 mm	9983	590x650x600
9531	20 bar	1' 1/4" (M) – 1' 1/4" (F)	25 mm	1' 1/4"	8 m	18 kg	200 mm	9982	330x650x600
9538	20 bar	1' 1/4" (M) – 1' 1/4" (F)	25 mm	1' 1/4"	20 m	49 kg	400 mm	9982	590x650x600
9539	20 bar	1' 1/2" (M) – 1' 1/2" (F)	32 mm	1' 1/2"	15 m	50 kg	400 mm	9983	590x650x600



**/HB Hydraulic spring brake kit**

Safety device for the controlled rewind of hoses, installable on all spring-driven hose reel models, eliminating the dangers caused by an uncontrolled rewind or a sudden release of the hose when unwinded during its use.

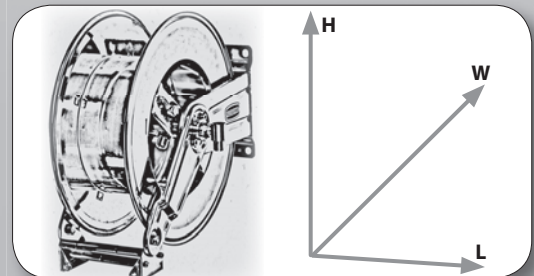

## Heavy duty series    Ø max 1/2" - up to 25 m length

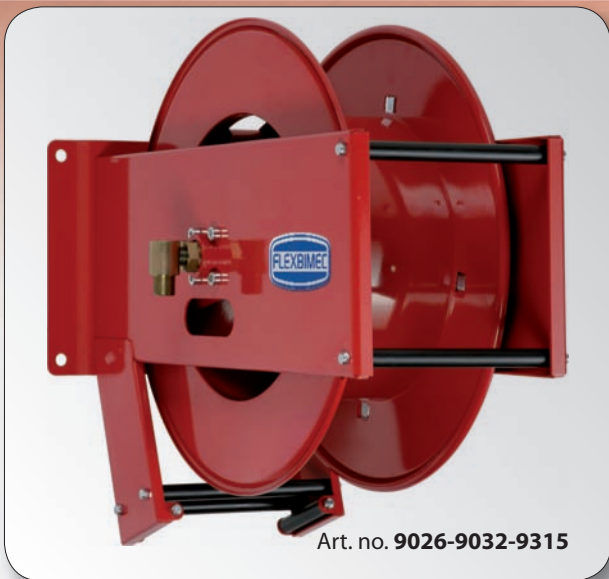

Art. no. **9026 - 9032 - 9315**

Automatic rewind, spring-driven hose reel, **heavy duty series**, in painted steel, suitable for hoses of max 25 m length and max diameter of 1/2". The hose reel is supplied without hoses and can be used with hoses for the supply of oils, antifreeze, grease, compressed air and water. Please see catalogue pages 242 and 243 for the selection of the required hoses.

On demand the hose reels can also be supplied with a **spring brake kit** (see information at the end of this page!); please add suffix **"/HB"** to the article number (f. ex. 9026/HB)!



Art. no. **9768**  
Pivoting wall mounting bracket for art. no. 9026 - 9032.

Art. no. **9767**  
Pivoting wall mounting bracket for art. no. 9315.



Art. no. **9523 - 9524 - 9532**

Automatic rewind, spring-driven hose reel, **heavy duty series**, in stainless steel AISI 304, suitable for hoses of max 20 m length and max diameter of 1/2". The hose reel is supplied without hoses and can be used with hoses for the supply of oils, antifreeze, grease, compressed air and water. Please see catalogue pages 242 and 243 for the selection of the required hoses.

On demand the hose reels can also be supplied with a **spring brake kit** (see information at the end of this page!); please add suffix **"/HB"** to the article number (f. ex. 9523/HB)!

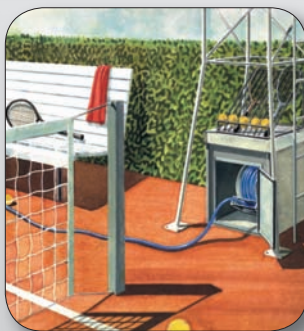

Art. no. **9760**  
Pivoting wall mounting bracket for art. no. 9523.

Art. no. **9765**  
Pivoting wall mounting bracket for art. no. 9524 - 9532.



On demand these stainless steel hose reels can be supplied in accordance with directive ATEX 94/9/EC - group II - category 2.

Art. no.	Max working pressure	Connection threads IN - OUT	Internal ø swivel joint	Max ø hose	Max length hose	Weight	Spool width	Suitable pivoting wall bracket	Included swivel joint	Dimensions (LxWxH) (mm)
<b>9315</b>	600 bar	1/2" (M) - 1/2" (F)	10 mm	1/2"	15 m	16 Kg	120 mm	9767	9951	300x550x450
<b>9026</b>	600 bar	1/2" (M) - 1/2" (F)	10 mm	1/2"	20 m	21 Kg	150 mm	9768	9951	300x550x450
<b>9032</b>	600 bar	1/2" (M) - 1/2" (F)	10 mm	1/2"	25 m	23 Kg	200 mm	9768	9951	350x550x450
<b>9523</b>	200 bar	1/2" (M) - 1/2" (F)	10 mm	1/2"	15 m	16 Kg	120 mm	9760	9963	300x550x450
<b>9524</b>	200 bar	1/2" (M) - 1/2" (F)	10 mm	1/2"	20 m	21 Kg	150 mm	9765	9963	300x550x450
<b>9532</b>	200 bar	1/2" (M) - 1/2" (F)	10 mm	1/2"	25 m	23 Kg	200 mm	9765	9963	350x550x450



### **/HB** Hydraulic spring brake kit

Safety device for the controlled rewind of hoses, installable on all spring-driven hose reel models, eliminating the dangers caused by an uncontrolled rewind or a sudden release of the hose when unwinded during its use.

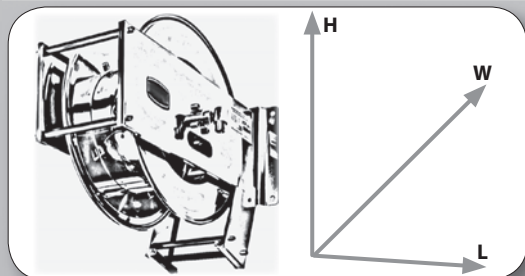



## Heavy duty series Ø max 1" - up to 12 m length

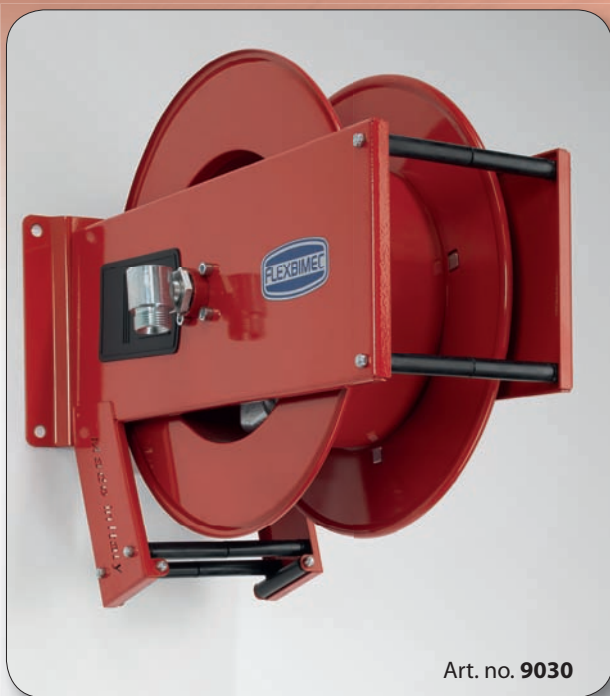

Art. no. 9030

Art. no. 9030

Automatic rewind, spring-driven hose reel, **heavy duty series**, in painted steel, suitable for applications with short distances and hoses of max 12 m length in 3/4" or max 8 m length in 1".

The hose reel is supplied without hoses and can be used with hoses for the supply of diesel, compressed air and water at low pressure.

Please see catalogue pages 242 and 243 for the selection of the required hoses.

On demand the hose reels can also be supplied with a **spring brake kit** (see information at the end of this page!); please add suffix **"/HB"** to the article number (f. ex. 9030/HB)!



Art. no. 9768

Pivoting wall mounting bracket for art. no. 9030.



Art. no. 9768



Art. no. 9529

Art. no. 9529

Automatic rewind, spring-driven hose reel, **heavy duty series**, in stainless steel AISI 304, suitable for applications and short distances with hoses of max 12 m length in 3/4" or max 8 m length in 1".

The hose reel is supplied without hoses and can be used with hoses for the supply of diesel, compressed air and water at low pressure.

Please see catalogue pages 242 and 243 for the selection of the required hoses.

On demand the hose reels can also be supplied with a **spring brake kit** (see information at the end of this page!); please add suffix **"/HB"** to the article number (f. ex. 9030/HB)!

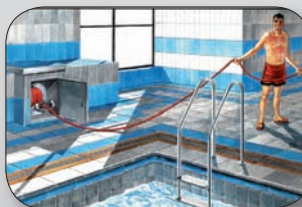

Art. no. 9765

Pivoting wall mounting bracket for art. no. 9529.



Art. no. 9765



On demand these stainless steel hose reels can be supplied in accordance with directive ATEX 94/9/EC - group II - category 2.

Art. no.	Max working pressure	Connection threads IN - OUT	Internal Ø swivel joint	Max Ø hose	Max length hose 3/4" - 1"	Weight	Spool width	Suitable pivoting wall bracket	Included swivel joint	Dimensions (LxWxH) (mm)
9030	100 bar	1" (M) - 1" (F)	20 mm	1"	12 m - 8 m	21 Kg	150 mm	9768	9969	550x300x450
9529	100 bar	1" (M) - 1" (F)	20 mm	1"	12 m - 8 m	21 Kg	150 mm	9765	9986	550x300x450



### /HB Hydraulic spring brake kit

Safety device for the controlled rewind of hoses, installable on all spring-driven hose reel models, eliminating the dangers caused by an uncontrolled rewind or a sudden release of the hose when unwinded during its use.

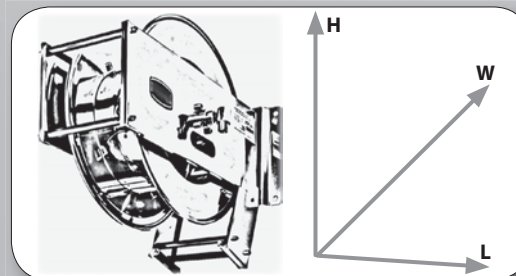

## Heavy duty series Ø max 1" - up to 25 m length

Art. no. **9034 - 9036**

Automatic rewind, spring-driven hose reel, heavy duty series, in painted steel, suitable for hoses of max 18 m length in 3/4" or max 15 m length in 1".  
The art. no. 9036 is equipped with a twin spring for the hose rewind.

The hose reel is supplied without hoses and can be used with hoses for the supply of oils, antifreeze, diesel, compressed air and water at low pressure.

Please see catalogue pages 242 and 243 for the selection of the required hoses.

On demand the hose reels can also be supplied with a **spring brake kit** (see information at the end of this page!); please add suffix **"/HB"** to the article number (f. ex. 9034/HB)!



Art. no. **9034 - 9036**



Art. no. **9769**

Pivoting wall mounting bracket for art. no. 9034.



Art. no. **9769**

Art. no. **9525 - 9536**

Automatic rewind, spring-driven hose reel, heavy duty series, in stainless steel AISI 304, suitable for hoses of max 18 m length in 3/4" or max 15 m length in 1".  
The art. no. 9536 is equipped with a twin spring for the hose rewind.

The hose reel is supplied without hoses and can be used with hoses for the supply of oils, antifreeze, diesel, compressed air and water at low pressure.



Art. no. **9525 - 9536**

Art. no. **9764**

Pivoting wall mounting bracket for art. no. 9525.



Art. no. **9764**



On demand these stainless steel hose reels can be supplied in accordance with directive ATEX 94/9/EC - group II - category 2.

Art. no.	Max working pressure	Connection threads IN - OUT	Internal ø swivel joint	Max ø hose	Max length hose 3/4" - 1"	Weight	Spool width	Suitable pivoting wall bracket	Included swivel joint	Dimensions (LxWxH) (mm)
<b>9034</b>	100 bar	1" (M) - 1" (F)	20 mm	1"	18 m - 15 m	24 Kg	300 mm	9769	9969	460x590x450
<b>9525</b>	100 bar	1" (M) - 1" (F)	20 mm	1"	18 m - 15 m	24 Kg	300 mm	9764	9986	460x590x450
<b>9036</b>	100 bar	1" (M) - 1" (F)	20 mm	1"	30 m - 25 m	36 Kg	400 mm	-	9969	520x550x540
<b>9536</b>	100 bar	1" (M) - 1" (F)	20 mm	1"	30 m - 25 m	36 Kg	400 mm	-	9986	520x550x540



### **/HB Hydraulic spring brake kit**

Safety device for the controlled rewind of hoses, installable on all spring-driven hose reel models, eliminating the dangers caused by an uncontrolled rewind or a sudden release of the hose when unwinded during its use.

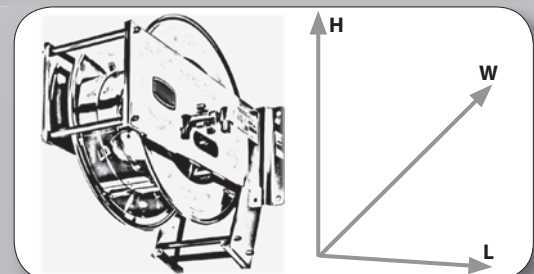



**Heavy duty series OX**

**Ø max 1" - up to 25 m length**

**Ø max 3/4" - up to 20 m length**

**5 YEARS WARRANTY!**



Art. no. **9065 -9066**

**Art. no. 9065 -9066**

Automatic rewind, spring-driven hose reel, **heavy duty series OX**, in painted steel, with twin spring and adjustable arms, suitable for hoses of max 25 m length in 3/4" or max 20 m length in 1".

The extreme robustness of its construction combined with the high rewinding strength of its twin spring characterize this innovative hose reel version which is particularly suitable for the use with high pressure hoses in 3/4" and 1" (SAE 100 R1T and SAE 100 R2T) for oils, grease and diesel.

The oversizing of its structure allows this hose reel series – for which 5 years warranty are granted - to achieve extraordinary performances in its use.

Please see catalogue pages 242 and 243 for the selection of the required hoses.

On demand the hose reels can also be supplied with a **spring brake kit** (see information at the end of this page!); please add suffix **"/HB"** to the article number (f. ex. 9065/HB)!

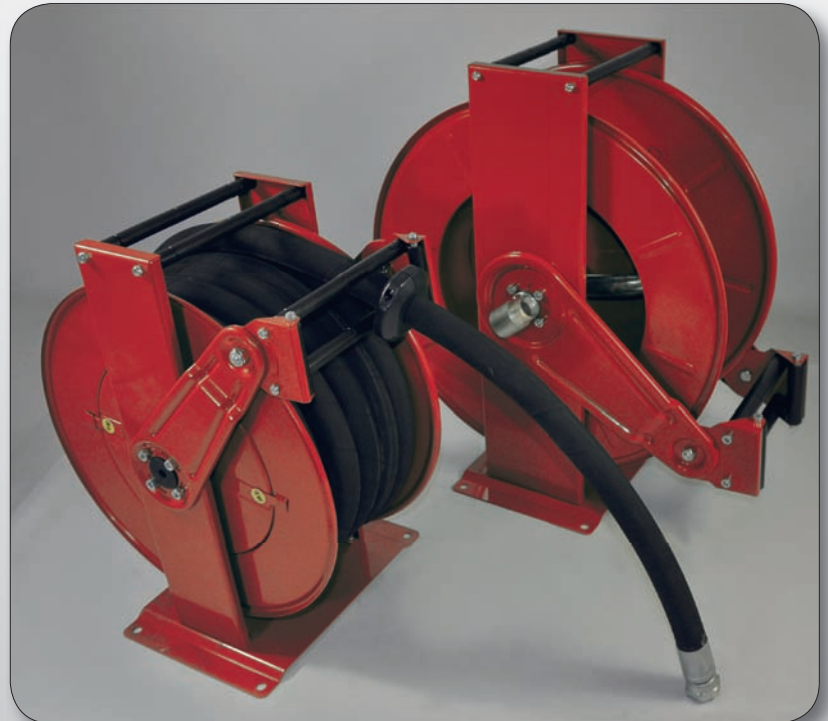
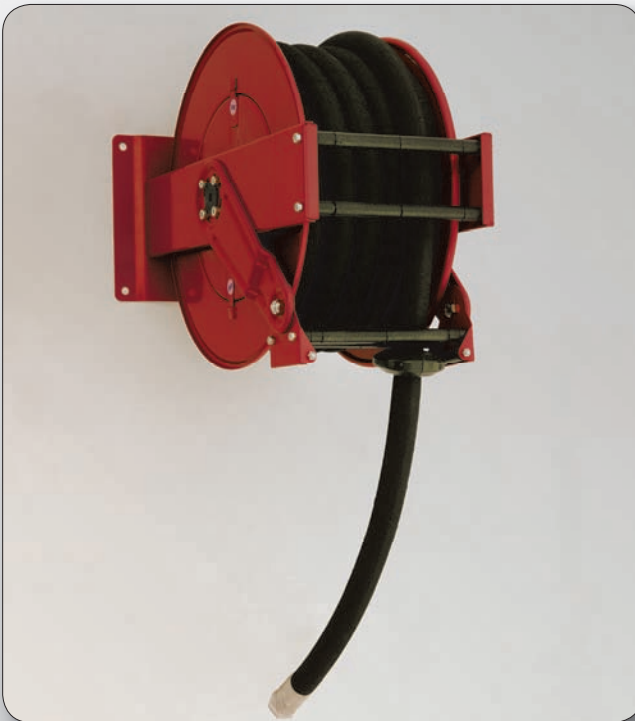

Art. no.	Max working pressure	Connection threads IN - OUT	Internal ø swivel joint	Max ø hose	Max length hose 3/4" - 1"	Weight	Spool width	Included swivel joint	Dimensions (LxWxH) (mm)
<b>9065</b>	200 bar	1" (M) - 1" (M)	20 mm	1"	20 m - 15 m	25 Kg	200 mm 450 mm	9979	270x600x490
<b>9066</b>	200 bar	1" (M) - 1" (M)	20 mm	1"	25 m - 20 m	32 Kg	200 mm 580 mm	9979	270x600x600



**/HB Hydraulic spring brake kit**

Safety device for the controlled rewind of hoses, installable on all spring-driven hose reel models, eliminating the dangers caused by an uncontrolled rewind or a sudden release of the hose when unwinded during its use.

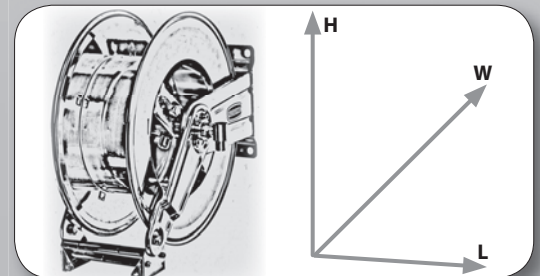



Art. no. 9060

Automatic rewind, spring-driven hose reel, **series THIN REEL**, in painted steel, suitable for hoses of max 25 m length and max diameter of 1/2".

Its innovative constructional design characterizes the models of this series which is particularly suitable in applications with limited space in width thanks to its overall width of max 150 mm, f. ex. for the installation inside of compact cabinets.

This hose reel is equipped with a swivelling bracket which allows a rotation of 90° so that a laterally installed reel can be used then forward-facing and can be repositioned easily again after use.

Please see catalogue pages 242 and 243 for the selection of the required hoses.

On demand the hose reels can also be supplied with a **spring brake kit** (see information at the end of this page!); please add suffix **"/HB"** to the article number (f. ex. 9060/HB)!

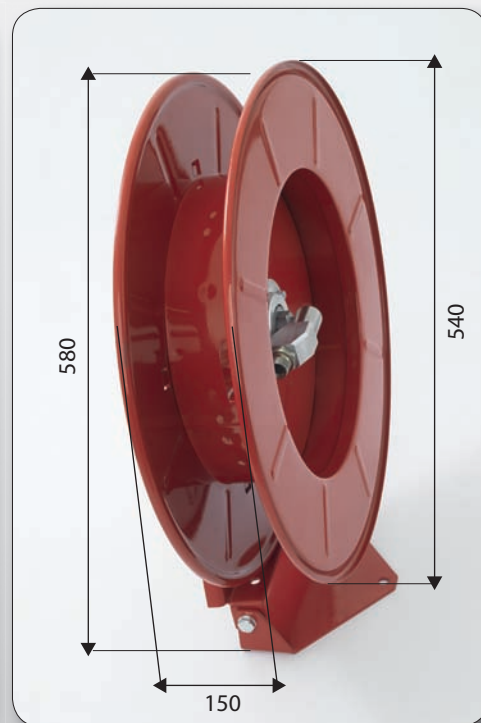

Art. no.	Max working pressure	Connection threads IN - OUT	Internal ø swivel joint	Max ø hose	Max length hose	Weight	Spool width	Included swivel joint	Dimensions (LxWxH) (mm)
<b>9060</b>	200 bar	1/2" (M) - 1/2" (M)	12 mm	1/2"	25 m	14 Kg	120 mm	9951	150x540x580



### **/HB Hydraulic spring brake kit**

Safety device for the controlled rewind of hoses, installable on all spring-driven hose reel models, eliminating the dangers caused by an uncontrolled rewind or a sudden release of the hose when unwinded during its use.